

# Container



**Rollcontainer** und Standcontainer von ophelis zeichnen sich aus durch eine Vielzahl an Varianten, Oberflächen und Grifflösungen. Ihre formale Neutralität ermöglicht Kombinationen mit allen Schreibtischen.



Mit den Containern von ophelis sind alle täglich benötigten Unterlagen und Materialien immer griffbereit. Sie sind frei kombinierbar mit allen Arbeitstischsystemen. Bei der Anzahl und Höhe der Schubladen bestehen zahlreiche Konfigurationsmöglichkeiten.

# Produktmerkmale

- Premium-Container
  - Als Stand- oder Rollcontainer
  - Slim-Container für mehr Beinfreiheit unter dem Tisch
  - Tiefen 600 und 800 mm
  - Rollengelagerte Voll-, Über- und Teilauszüge mit Selbsteinzug und Dämpfer
  - Staubdichtigkeit und geräuscharmes Verschließen der Schubladen: Seitenwände mit umlaufender Dichtlippe versehen
  - Schubladen aus Stahlblech mit Seitenschürze
  - Rückwand verleimt und verdübelt
  - Kippsicherheit durch Ausgleichsgewicht
  - Auszugssperre gegen Quetschungen und Kippgefahr
  - Gebremste Rollen für mehr Standfestigkeit und Arbeitssicherheit
  - Abschließbar, mit Klappschlüssel
  - Auswahl an Griffen oder grifflos (Schubladenfronten und Abdeckplatte mit seitlichem Überstand)
  - Optional mit Sitzkissen bestückbar, für Kurzbesprechungen am Arbeitsplatz
- Basis-Container
  - Nur Tiefe 800 mm
  - Teil- und Überauszug
  - Schubladen aus Stahlblech ohne Seitenschürzen
  - Ohne Selbsteinzug und Dämpfer

# Maße

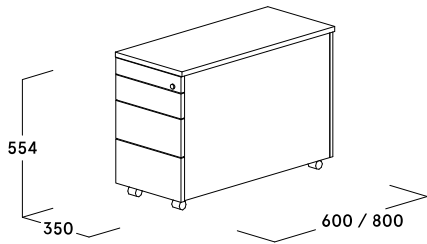
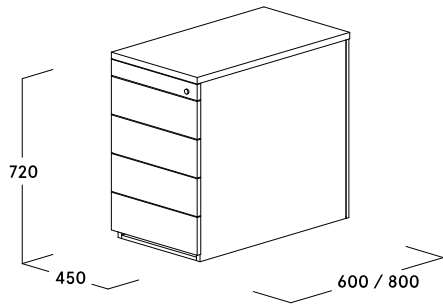
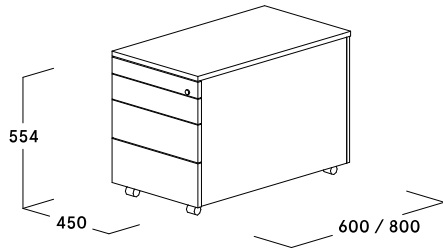

# Farben und Materialien

## Stoffe: Kvadrat Remix 3 (PG 21)

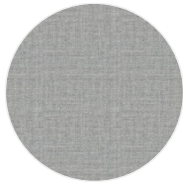

123

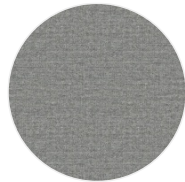

133

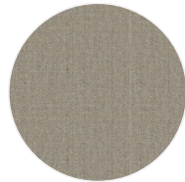

233

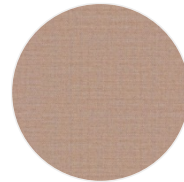

612

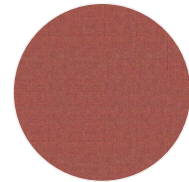

653

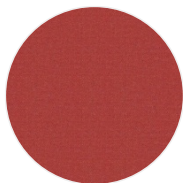

643

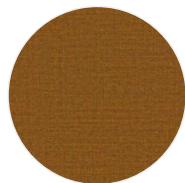

422

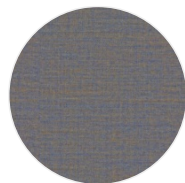

722

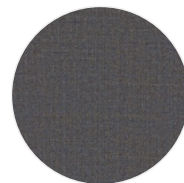

852

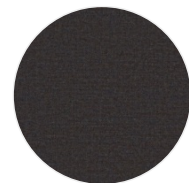

362



733

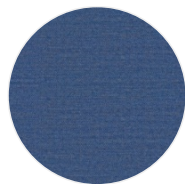

762

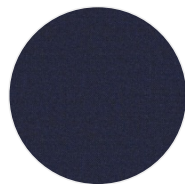

773

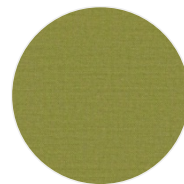

912

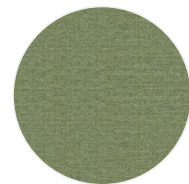

933

## Stoffe: Kvadrat Atlas (PG 21)

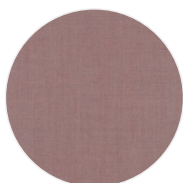

0621

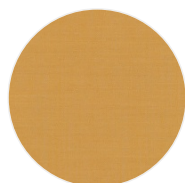

0451

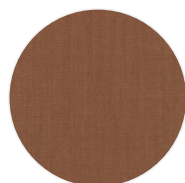

0471

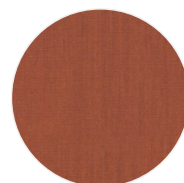

0561

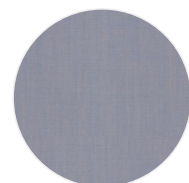

0631

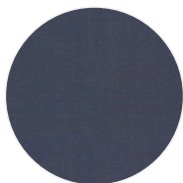

0861

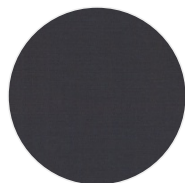

0881

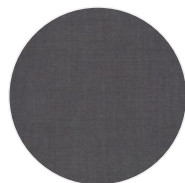

0161

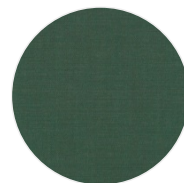

0951

**Stoffe: Kvadrat Steelcut Trio 3 (PG 22)**

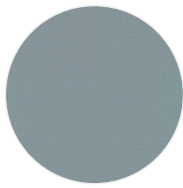

713

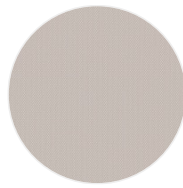

213

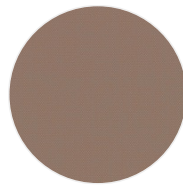

426

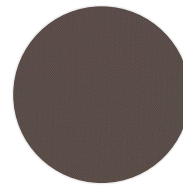

276

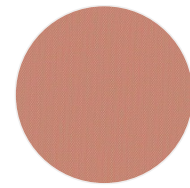

515

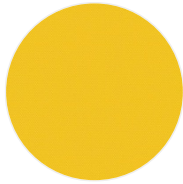

446

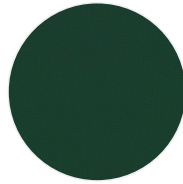

976

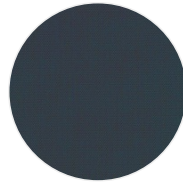

883

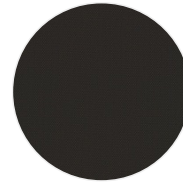

383

**Stoffe: Kvadrat Fiord 2 (PG 22)**

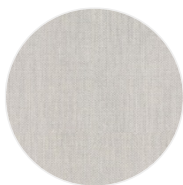

101

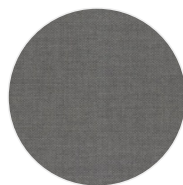

151

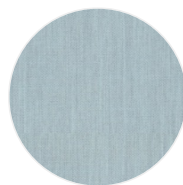

721

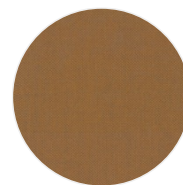

451

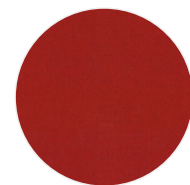

571



581

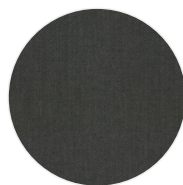

971

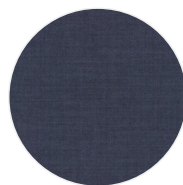

771

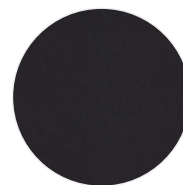

981

**Stoffe: Kvadrat Febrik Nitto (PG 22)**

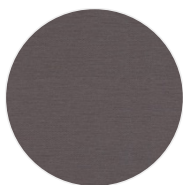

0137

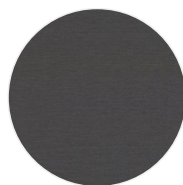

0167

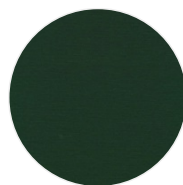

0997

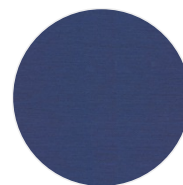

0747

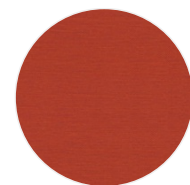

0547

**Stoffe: Kvadrat Field 2 (Funktionsstoff) (DIN 4102 B1) (PG 22)**

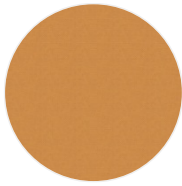

0463

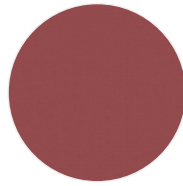

0643

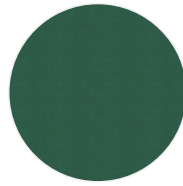

0963

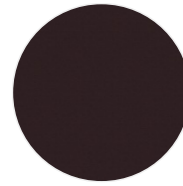

0693

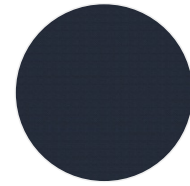

0782

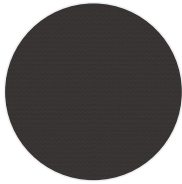

0182

**Stoffe: Kvadrat Patio (Funktionsstoff) (DIN 4102 B1) (PG 22)**

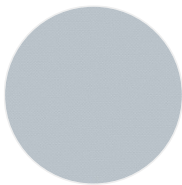

0140

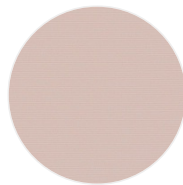

0340

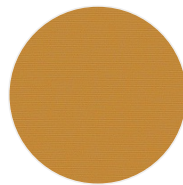

0450

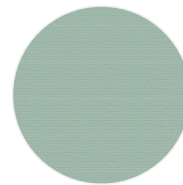

0840

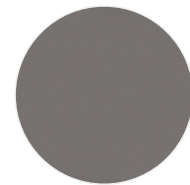

0150

**Stoffe: Kvadrat Febrik Mosaic 2 (PG 23)**

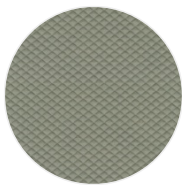

0922

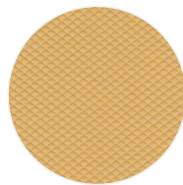

0422



0682

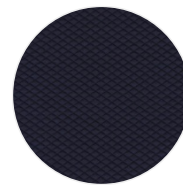

0692

**Stoffe: Kvadrat Febrik Plecto (PG 23)**

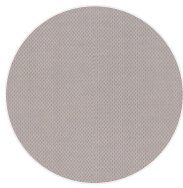

0224

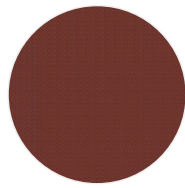

0564

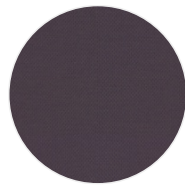

0654



0984

**Stoffe: Kvadrat Hallingdal 65 (PG 23)**

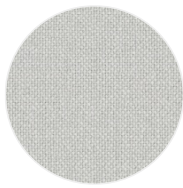

0103

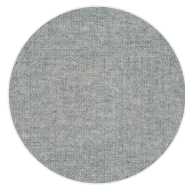

0116

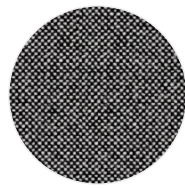

0166

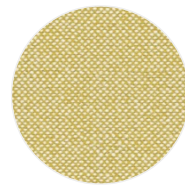

0407

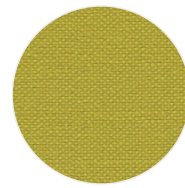

0420



0687



0764

**Stoffe: Kvadrat Divina 3 (PG 23)**

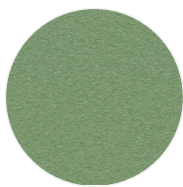

0856

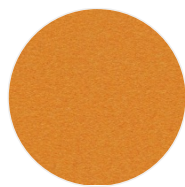

0444

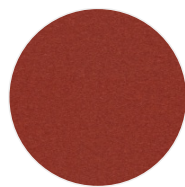

0584

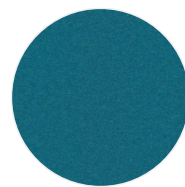

0893

**Stoffe: Kvadrat Divina Melange 3 (PG 23)**



0260



0567

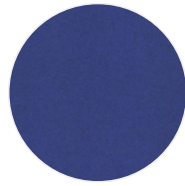

0747

**Stoffe: Kvadrat Divina MD (PG 23)**

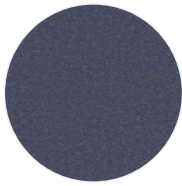

0753

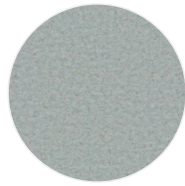

0813

**Stoffe: Kvadrat Coda 2 (PG 26)**



116



442



962



382

**Stoffe: Camira Blazer (PG 21)**

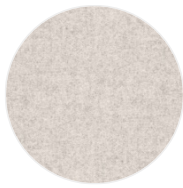

CUZ2Q



CUZ28

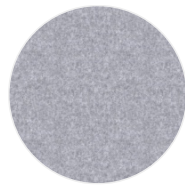

CUZ1E

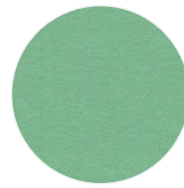

CUZ2Y

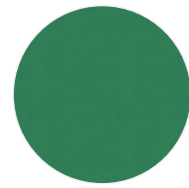

CUZ3A

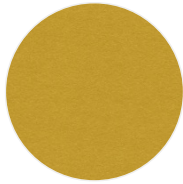

CUZ2W



CUZ21

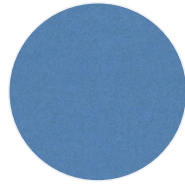

CUZ1V

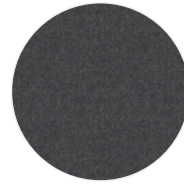

CUZ67

**Stoffe: Camira Mainline Flax (PG 21)**

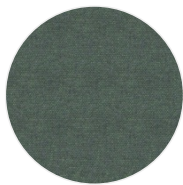

MLF32

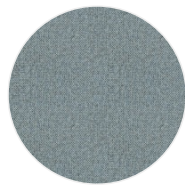

MLF22

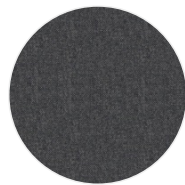

MLF16

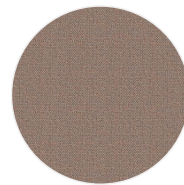

MLF23

**Stoffe: Camira Synergy (PG 21)**

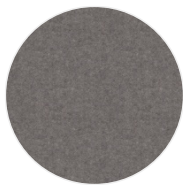

LDS35

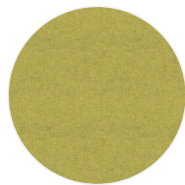

LDS46

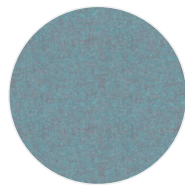

LDS56

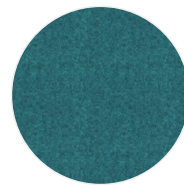

LDS59

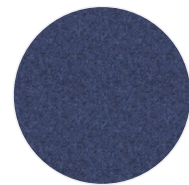

LDS62

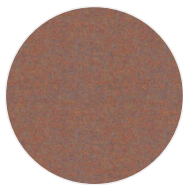

LDS76

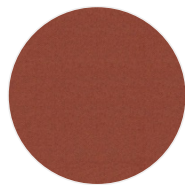

LDS77

**Stoffe: Camira Vita (Funktionsstoff) (PG 21)**



ITA03



ITA11

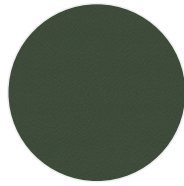

ITA29

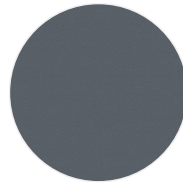

ITA04



ITA22

**Oberflächen: Furnier**



Ahorn Natur



Ahorn Natur  
geölt



Eiche  
weißgekalkt



Eiche  
weißgekalkt  
geölt



Eiche Natur



Eiche geölt

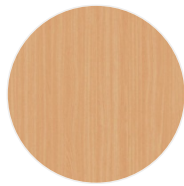

Buche Natur



Kirschbaum

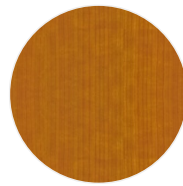

Kirschbaum  
geölt



Nussbaum



Nussbaum geölt



Zebrano



Räuchereiche

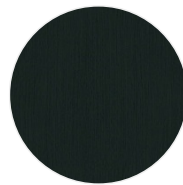

Eiche schwarz

## Oberflächen: Melamin



Atlasweiß



Cremeweiß



Softweiß



Lichtgrau

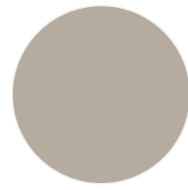

Seidengrau

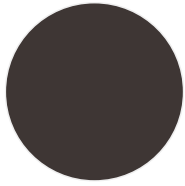

Graubraun

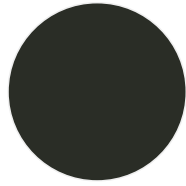

Graphit

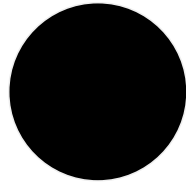

Schwarz



Ahorn Dekor



Eiche hell



Buche hell

## Oberflächen: Lack



Verkehrsweiß  
(RAL 9016)



Cremeweiß  
(RAL 9001)



Seidengrau  
(RAL 7044)

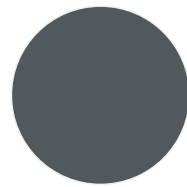

Eisengrau  
(RAL 7011)

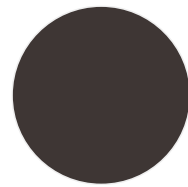

Graubraun  
(RAL 8019)