

MILLEPIEDI

Parisotto + Formenton

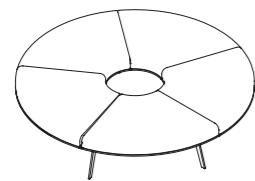

SINGLE

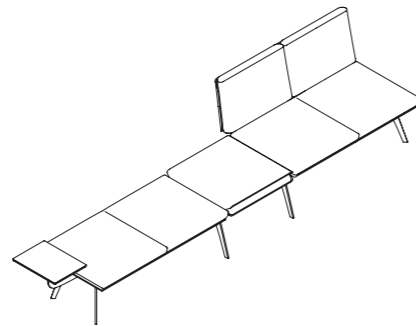

MODULAR
MODULARE - MODULAIRE

COLORS AND MATERIALS

COLORI E MATERIALI - COULEURS ET MATÉRIAUX

WOOD LEGNO - BOIS



ashwood
frassino
frêne

Standard finishing for wood is natural oakwood. Customized RAL colors are available upon request.

La finitura standard del legno è il rovere naturale. Su richiesta sono disponibili colorazioni customizzate su tinta RAL.

Les finitions standard pour le bois est en chêne naturel. Des couleurs personnalisées RAL sont disponibles sur demande.

STEEL ACCIAIO - ACIER



Click on the icon to see the standard RAL finishings for the steel bases on the dedicated page. Customized RAL colors finishings are available upon request.

Clicca sull'icona per vedere le finiture RAL standard delle basi in acciaio sulla pagina dedicata. Su richiesta sono disponibili colorazioni customizzate su altre tinte RAL.

Cliquez sur l'icône pour voir les finitions RAL standard des bases en acier sur la page dédiée. Des couleurs RAL personnalisées sont disponibles sur demande.

TECHNICAL FEATURES

SPECIFICHE TECNICHE - SPÉCIFICATIONS TECHNIQUES

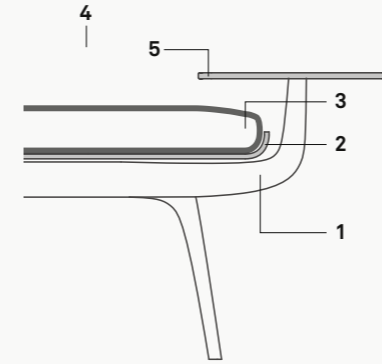

1. Steel frame

Telaio in acciaio
Structure en acier

2. Wooden seating support

Supporto seduta in legno
Support de siège en bois

3. Polyurethane foam

Poliuretano espanso
Mousse polyuréthane

4. Upholstery

Rivestimento
Revetement

5. Wooden table

Tavolino in legno
Table en bois

Steel beam frame, powder coated, with laser cut legs; main structure of seat and backrest in multilayer beechwood, with natural oakwood veneer; padded in polyurethane high density foam, upholstered with fabric and leather.

Poutre en acier vernis, avec pieds en acier coupé au laser; structure portante de assise et dossier en multiplis d'hêtre avec finition en chêne naturel; rembourré en mousse polyuréthane haute densité, recouvert en tissu ou cuir.

Telaio a trave in acciaio verniciato con gambe tagliate a laser; struttura portante di sedile e schienale in multistrato di faggio con finitura rovere naturale; imbottitura in poliuretano espanso ad alta densità, e rivestimento in tessuto o pelle.

MODULAR BEAM SYSTEM

SISTEMA TRAVI MODULARI - SYSTÈME DE POUTRE MODULAIRE

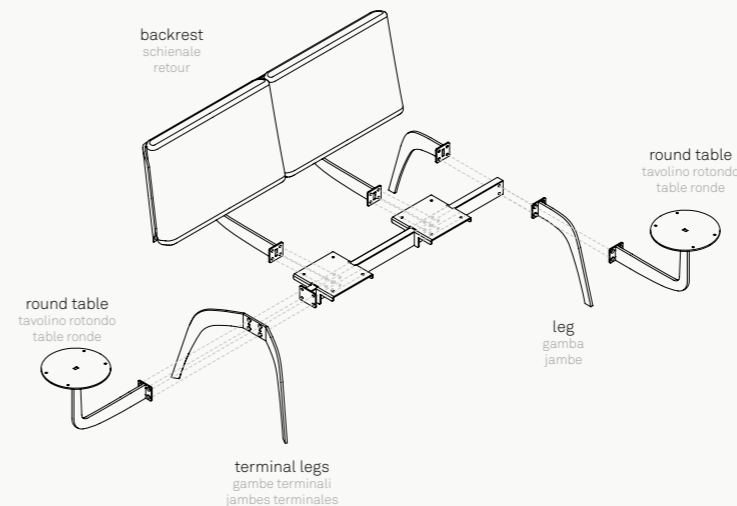

MP 2000
2 seater bench
panca 2 posti
banquette 2 places

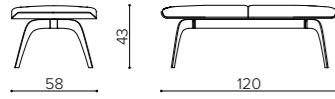

m 1,4 ♻️ mq 2,7 📦 kg 25 🛠️ mc 0,3

MP 3000
3 seater bench
panca 3 posti
banquette 3 places

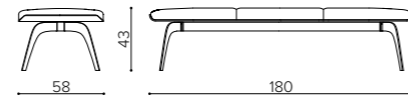

m 1,6 ♻️ mq 2,8 📦 kg 35 🛠️ mc 0,45

MP SR00
right "S" element
elemento "S" destro
"S" élément droit

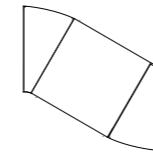
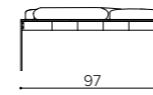

m 1,5 ♻️ mq 2,9 📦 kg 15 🛠️ mc 0,15

MP SL00
left "S" element
elemento "S" sinistro
"S" élément gauche

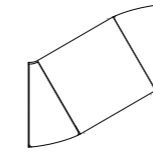
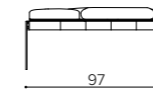

MP 1L00
side 1 seater module
elemento singolo terminale
élément terminal unitaire

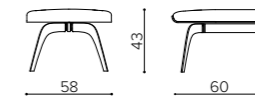

m 0,7 ♻️ mq 1,4 📦 kg 10 🛠️ mc 0,15

MP 2L00
side 2 seater bench
panca 2 posti terminale
banquette 2 places côté

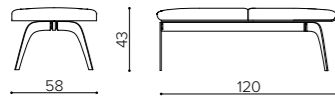

m 1,4 ♻️ mq 2,7 📦 kg 20 🛠️ mc 0,3

MP 3L00
side 3 seater bench
panca 3 posti terminale
banquette 3 places côté

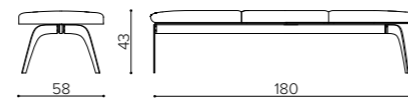

m 1,6 ♻️ mq 2,8 📦 kg 30 🛠️ mc 0,45

MP 330W
3 seater backrest module
elemento singolo terminale
dossier 3 places

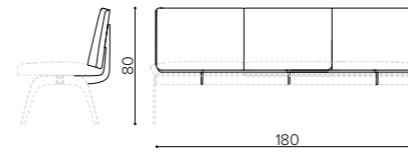

m 1,8 ♻️ mq 3 📦 kg 15 🛠️ mc 0,2

MP 220W
2 seater backrest module
modulo schienale 2 posti
dossier 2 places

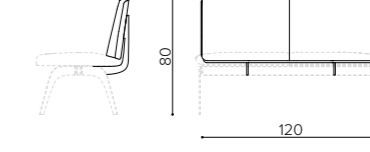

m 1,6 ♻️ mq 2,7 📦 kg 10 🛠️ mc 0,15

MP 2C00
central 2 seater bench
panca 2 posti centrale
banquette 2 places centrale

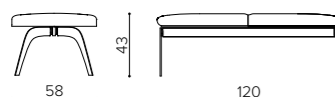

m 1,4 ♻️ mq 2,7 📦 kg 20 🛠️ mc 0,3

MP 3C00
central 3 seater bench
panca 3 posti centrale
banquette 2 places centrale

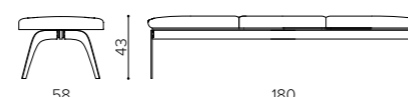

m 1,6 ♻️ mq 2,8 📦 kg 30 🛠️ mc 0,45

MP A000
corner element
elemento angolare
élément angle

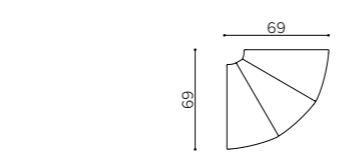
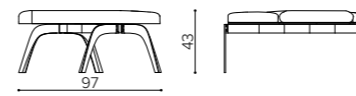

m 1,5 ♻️ mq 2,9 📦 kg 15 🛠️ mc 0,2

MP BB00
armrest
bracciolo
accoudoir

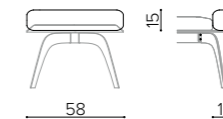

m 0,3 ♻️ mq 0,55 📦 kg 0,5 🛠️ mc 0,05

MP 5P0S
square low bench
panca bassa quadrata
banquette basse carré

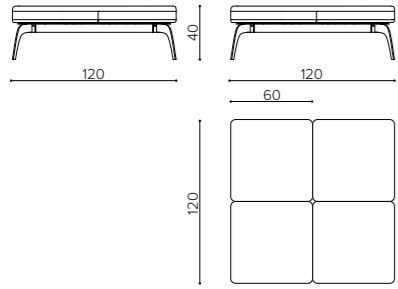



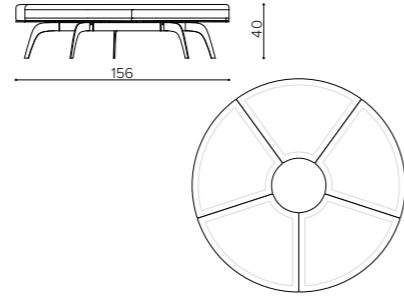

■ m 4,5 □ mq 8 ⚖ kg 65 ✂ mc 0,57

MP 5P0R
circular low bench
panca bassa circolare
banquette basse rond



■ m 5 □ mq 8,5 ⚖ kg 75 ✂ mc 1,5

BENCH TABLES
TAVOLINI PER PANCHE - TABLES POUR BANC

-  Bench side table
Tavolo laterale panca
Table d'appoint latéral
-  Bench front table
Tavolo frontale panca
Table d'appoint central
-  Circular bench inside table
Tavolo interno panca circolare
Table circulaire banc - à l'intérieur
-  Circular bench outside table
Tavolo esterno panca circolare
Table circulaire banc - à l'extérieur
-  Square bench outside table
Tavolo esterno panca quadrata
Table carrée banc - à l'extérieur

MPTR01
single central table
panca bassa quadrata
table centrale unique

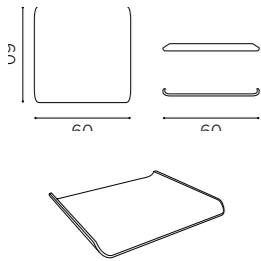

⚖ kg 1,0 ✂ mc 0,015

MPTR02
double central table
tavolino centrale doppio
table centrale dopée

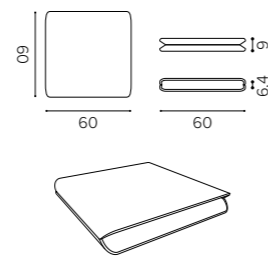

⚖ kg 2,0 ✂ mc 0,03

MPTRE2
double central table with power supply
tavolino centrale doppio con elettrificazione
table centrale dopée avec électrification

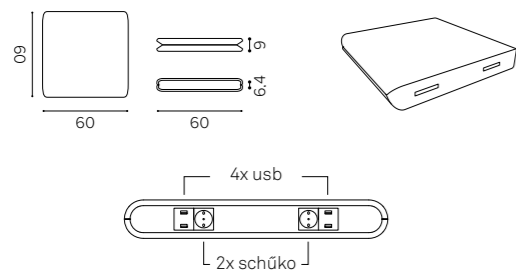

⚖ kg 2,0 ✂ mc 0,03

power outlet
presa alimentazione
prise de courant

USB outlet
presa ricarica usb
prise de charge usb

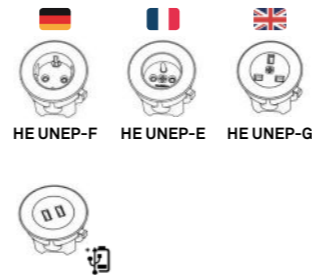

ACCESSORIES
Accessory always contains 2x USB + 1x power socket
L'accessorio contiene sempre 2x USB + 1x presa elettrica
L'accessoire contient toujours 2x USB + 1x presa elettrica

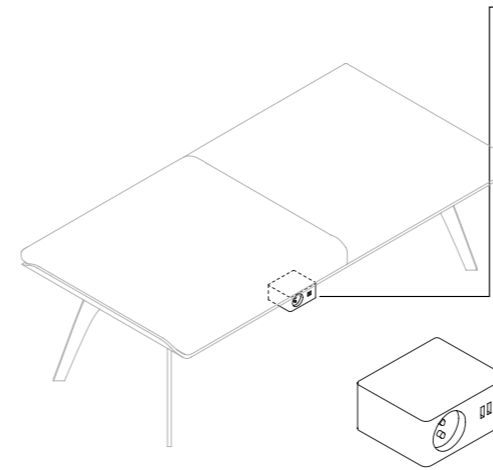

power outlet
presa alimentazione
prise de courant

2x USB
2x USB
2x USB

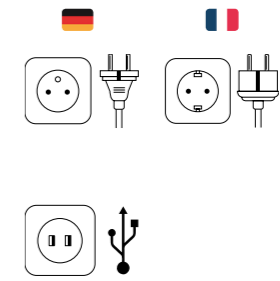

COFFEE TABLES
TAVOLINI DA CAFFÈ - TABLE BASSE



click to reach the Millepiedi table collection page
clicca per raggiungere la pagina dei tavoli Millepiedi
cliquez pour accéder à la page de collection de tables Millepiedi

CONFIGURATION EXAMPLE

ESEMPIO COMPOSIZIONE - EXEMPLE CONFIGURATION

MP BB00 + MP 3L00 + MP TFOR + MP SL00 + MP 220W + MP 2C00 + MP 2L00 + MP TLOR

configuration example 1

esempio composizione 1

exemple configuration 1

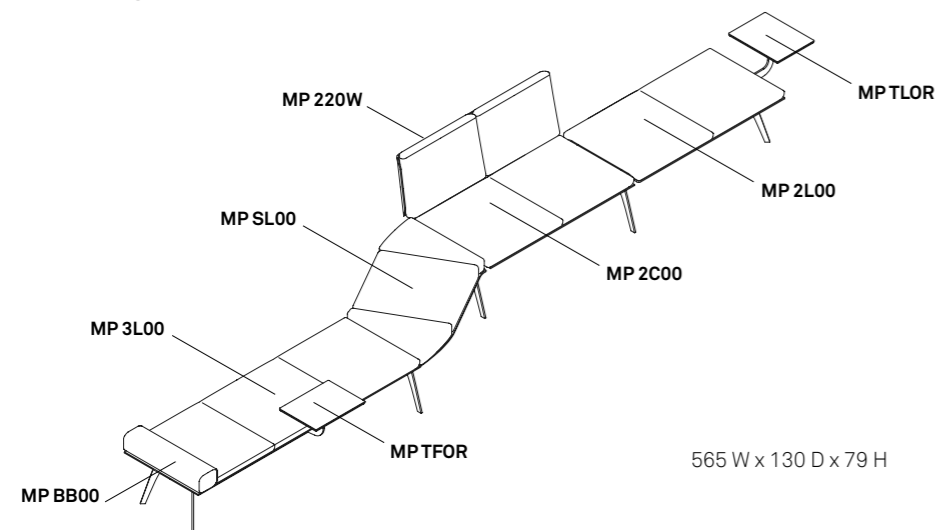

MP BB00 + MP 3L00 + MP 330W + MP 2L00 + MP 220W

configuration example 2

esempio composizione 2

exemple configuration 2

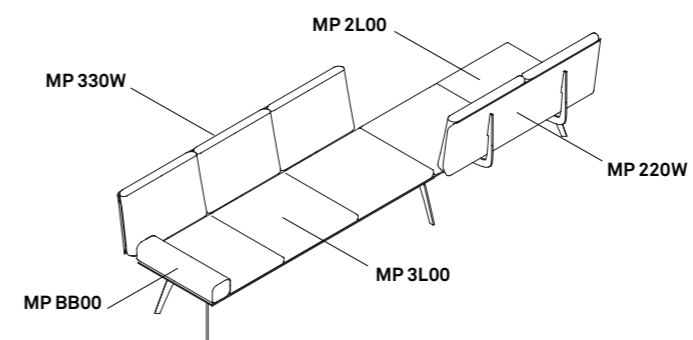

MP TLOR + MP 2L00 + MP 2C00 + MP 220W + MP A000 + MP 3L00 + MP BB00

configuration example 3

esempio composizione 3

exemple configuration 3

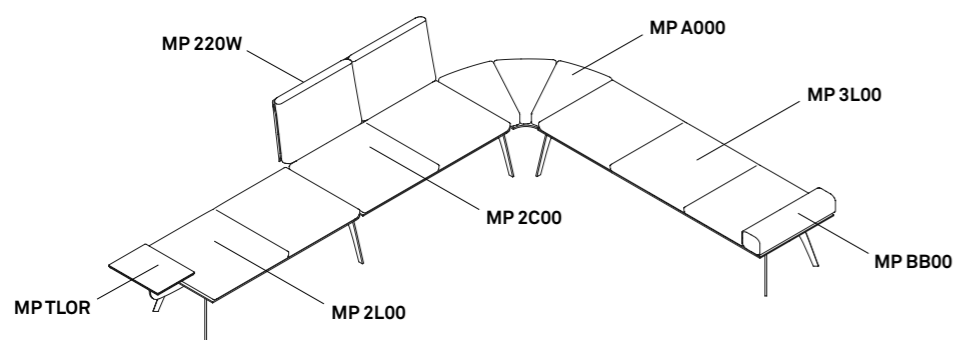

MP TLOR + 2x MP 2L00 + MP TRE2 + MP 220W

configuration example 4

esempio composizione 4

exemple configuration 4

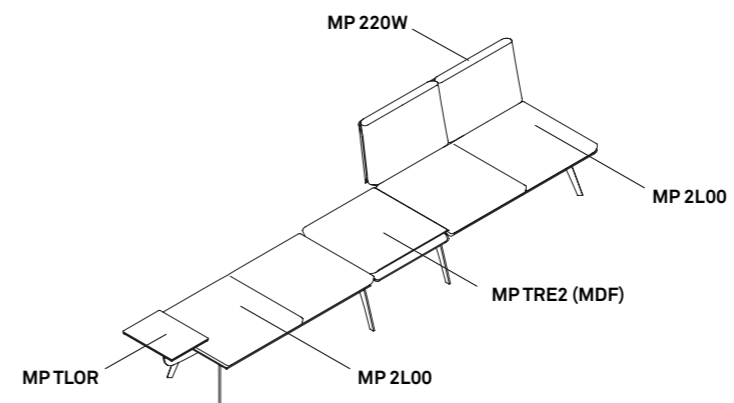

MILLEPIEDI

Parisotto+Formenton



TECHNICAL FEATURES

SPECIFICHE TECNICHE - SPÉCIFICATIONS TECHNIQUES

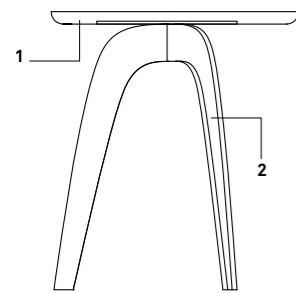

- 1. Oakwood or marble top**
Piano in rovere o marmo
Plateau en chêne ou en marbre
- 2. Laser cut steel base**
Base in acciaio tagliato a laser
Base en acier découpé au laser

COLORS AND MATERIALS

COLORI E MATERIALI - COULEURS ET MATÉRIAUX

STEEL FRAME

STRUTTURA IN ACCIAIO - STRUCTURE EN ACIER



Click on the icon to see the standard RAL finishings for the steel bases on the dedicated page. Customized RAL colors finishings are available upon request.

Clicca sull'icona per vedere le finiture RAL standard delle basi in acciaio sulla pagina dedicata. Su richiesta sono disponibili colorazioni customizzate su altre tinte RAL.

Cliquez sur l'icône pour voir les finitions RAL standard des bases en acier sur la page dédiée. Des couleurs RAL personnalisées sont disponibles sur demande.

MARBLE TOP

PIANO IN MARMO - PLATEAU EN MARBRE

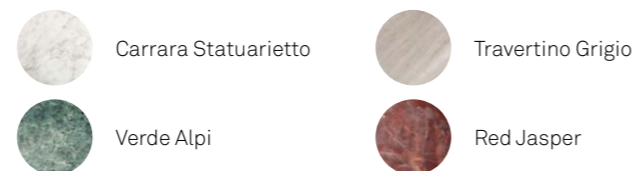

WOODEN TOP

PIANO IN LEGNO - PLATEAU EN BOIS

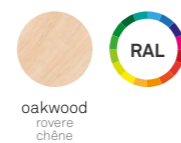

The standard finishing for the top is natural oakwood. Customized RAL colors are available upon request.

La finitura standard del piano in legno è il rovere naturale. Su richiesta sono disponibili colorazioni customizzate su altre tinte RAL.

La finition standard du plateau est en chêne naturel. Des couleurs RAL personnalisées sont disponibles sur demande.

MP TR00

low table

tavolino basso
table basse

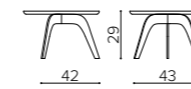

kg 8
wood
legno
bois

kg 18
marble
marmo
marbre

mc 0,07

MP TR0L

medium table

tavolino basso
table moyenne

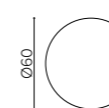

kg 10,5
wood
legno
bois

kg 20,5
marble
marmo
marbre

mc 0,13

MP TR0H

high table

tavolo alto
table haut

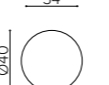
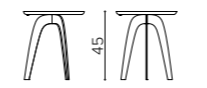

kg 10
wood
legno
bois

kg 18
marble
marmo
marbre

mc 0,07

UPHOLSTERY CATEGORIES

CATEGORIE RIVESTIMENTI - CATÉGORIES DE TISSUS D'AMEUBLEMENT

S	camira	GRAVITY	76% Polyester, 24% Recycled Polyester, non metallic dyestuffs 76% Poliestere, 24% Poliestere riciclato, coloranti non metallici 76% Polyester, 24% Polyester recyclé, colorants non métalliques
	FIDIVI	LASER N	100% Polyester Trevira CS 100% Poliestere Trevira CS - 100% Polyester Trevira CS
	FIDIVI	ONE	100% Recycled polyester 100% Poliestere riciclato - 100% Polyester recyclé
T	FIDIVI	MAYA	100% Polyester Trevira CS 100% Poliestere Trevira CS - 100% Polyester Trevira CS
	FIDIVI	INCAS	100% Polyester Trevira CS 100% Poliestere Trevira CS - 100% Polyester Trevira CS
	FIDIVI	LASER J & J FLASH	100% Polyester Trevira CS 100% Poliestere Trevira CS - 100% Polyester Trevira CS
M	kvadrat	FIELD 2	100% Polyester Trevira CS 100% Poliestere Trevira CS - 100% Polyester Trevira CS
	FIDIVI	CORTE	100% Polyester Trevira CS 100% Poliestere Trevira CS - 100% Polyester Trevira CS
	camira	MAIN LINE FLAX	70% Virgin Wool, 30% Flax 70% Lana Vergine, 30% Lino - 70% Laine vierge, 30% Lin
	SPRADLING®	VALENCIA	Vinyl / Urethane Topcoat Finitura in vinile / uretano - Revêtement de finition vinyle / uréthane
F	camira	SYNERGY	95% Virgin Wool, 5% Polyamide 95% Lana Vergine, 5% Poliammide - 95% Laine vierge, 5% Polyamide
	kvadrat	REMIX 3	90% New wool (worsted), 10% Nylon 90% Lana vergine (pettinata), 10% Nylon - 90% Laine vierge (peignée), 10% Nylon
L	maharam	MERIT	76% Recycled polyester, 24% Polyester 76% Poliestere riciclato, 24% Poliestere - 76% Polyester recyclé, 24% Polyester
	kvadrat	MEMORY 2	100% Polyester Trevira CS 100% Poliestere Trevira CS - 100% Polyester Trevira CS
	kvadrat	COLLINE 2	75% New wool (worsted), 17% Acrylic, 8% Nylon 75% Lana vergine (pettinata), 17% Acrilico, 8% Nylon 75% Laine vierge (peignée), 17% Acrilico, 8% Nylon
P	DANI	PANAMA GENUINE LEATHER	Chrome tanned european bovine raw hides Pelle bovina europea ai sali di cromo - Cuir de bovin européenne avec sels de chrome
PX	FEBRIK kvadrat	UNIFORM MELANGE	European bovine leather, full grain Pelle pieno fiore, bovina europea - Cuir de bovin européen, pleine fleur
	elmo	BALTIQUE FULL GRAIN LEATHER	European bovine leather Pelle bovina europea - Cuir de bovin européen

OUTDOOR UPHOLSTERY CATEGORIES

CATEGORIE RIVESTIMENTI OUTDOOR - CATÉGORIES DE TISSUS D'AMEUBLEMENT OUTDOOR

M	SPRADLING®	MAGLIA	Vinyl / Urethane Topcoat Finitura in vinile / uretano - Revêtement de finition vinyle / uréthaneD
F	DELIUS WORLD OF TEXTILES SINCE 1752	GOA	100% Polyolefinic FR 100% Poliolefinico FR - 100% Polyoléfinique FR
	DELIUS WORLD OF TEXTILES SINCE 1752	TONGA	100% Polyolefinic FR 100% Poliolefinico FR - 100% Polyoléfinique FR
L	DELIUS WORLD OF TEXTILES SINCE 1752	ARUBA	100% Polyolefinic FR 100% Poliolefinico FR - 100% Polyoléfinique FR
	DELIUS WORLD OF TEXTILES SINCE 1752	BALI	100% Polyolefinic FR 100% Poliolefinico FR - 100% Polyoléfinique FR
	DELIUS WORLD OF TEXTILES SINCE 1752	HAITI	100% Polyolefinic FR 100% Poliolefinico FR - 100% Polyoléfinique FR

OUTDOOR USE AND MAINTENANCE

USO E MANUTENZIONE PER L'OUTDOOR - UTILISATION ET MAINTENANCE POUR L'EXTÉRIUR



STEEL
METALLO/MÉTAL

Steel is used in the manufacture of metal products. This material galvanised and powder-coated, is ideal for outdoor use. Regarding products intended for seaside locations we recommend cleaning on a quarterly basis, with a cloth using water or mild detergents. During the winter period we recommend storing the furniture in closed, dry rooms in order to prevent condensation. In fact, although our products are suitable for outdoor use, during colder months the products should be stored in a closed, dry place in order to prevent moisture and seasonal frosts from affecting the finish.

Nella realizzazione dei prodotti metallici viene impiegato l'acciaio, il quale in seguito al processo di zincatura e di verniciatura a polveri, risulta ideale per l'utilizzo outdoor. Durante il periodo invernale consigliamo di conservare gli arredi in luoghi chiusi ed asciutti per evitare la formazione di condensa. Per i prodotti destinati a località marittime consigliamo con cadenza trimestrale una pulizia con un panno utilizzando acqua o detersivi non aggressivi. Nonostante i nostri prodotti siano adatti all'ambiente esterno, durante il periodo invernale è consigliato il ricovero dei prodotti in un luogo chiuso ed asciutto. In modo da evitare che l'umidità unita alle gelate stagionali possa in qualche modo intaccare le finiture.

L'acier est la matière première utilisée dans la fabrication de ces produits métalliques qui, après un processus de galvanisation et un revêtement de finition par poudre, sont idéaux pour une utilisation en extérieur. Pour les produits destinés à être utilisés en bord de mer, nous recommandons un nettoyage trimestriel avec un chiffon utilisant de l'eau ou des détergents doux. Bien que nos produits soient adaptés à un usage extérieur, nous recommandons de les stocker dans un endroit fermé et sec pendant l'hiver; ceci afin d'éviter que l'humidité combinée aux gelées saisonnières n'affecte d'une manière ou d'une autre les finitions.

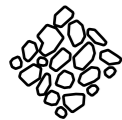

STONE
PIETRA/PIERRE

The stone tops are made of Marble or Quarella and they are ideal for the outdoor environment. Use a soft cloth with just water for daily cleaning. Avoid the use of aggressive abrasive sponges or steel wool pads. The furnishings made of stone such as marble and Quarella, during the first week of use will undergo a slight dulling due to contact with external elements. This is a natural phenomenon which does not affect the quality of the material. When the furniture is placed in seaside locations or swimming pools, cleaning with fresh water on a quarterly basis is recommended in order to avoid water corrosion due to salt build-up or chlorosis. Although our products are suitable for outdoor use, during colder months the products should be stored in a closed, dry place in order to prevent moisture and seasonal frosts from affecting the finish.

Materiale composito autoportante adatto all'ambiente Outdoor. Utilizzare un panno morbido con sola acqua per la pulizia quotidiana. In caso di necessità utilizzare detersivi non aggressivi. Evitare l'impiego di spugne abrasive o pagliette in acciaio. Nel caso di collocamento degli arredi in località marittime o piscine, si consiglia una pulizia trimestrale utilizzando acqua dolce per evitare principi di corrosione dovuti ad accumuli salini o clorosi. Nonostante i nostri prodotti siano adatti all'ambiente esterno, durante il periodo invernale è consigliato il ricovero dei prodotti in un luogo chiuso ed asciutto. In modo da evitare che l'umidità unita alle gelate stagionali possa in qualche modo intaccare le finiture.

Les dessus en pierre sont en marbre ou en quarella, idéaux pour une utilisation en extérieur. Utilisez un chiffon doux avec de l'eau uniquement pour le nettoyage quotidien. Évitez d'utiliser des détergents agressifs, des éponges abrasives ou des tampons de laine d'acier. Les meubles en pierre tels que le marbre et la Quarella, pendant la première semaine, subissent un léger ternissement dû au contact avec les éléments extérieurs. Il s'agit d'un phénomène naturel, qui n'affecte pas la qualité du matériau. Si le meuble est placé dans des stations balnéaires ou des piscines, nous recommandons un nettoyage trimestriel à l'eau douce pour éviter la corrosion due à l'accumulation de sel ou à la chlorose. Bien que nos produits conviennent à une utilisation en extérieur, il est recommandé, pendant la période hivernale, de stocker les produits dans un endroit fermé et sec, afin d'éviter que l'humidité combinée aux gelées saisonnières n'affecte d'une manière ou d'une autre la finition.



FABRICS
PIETRA/TISSU

The fabrics used are naturally resistant to climatic elements, UV-resistant and anti-microbial. After heavy rainfall it is recommended to remove the cushions for quick drying and in order to prevent condensation. When the furniture is placed in seaside locations or swimming pools, cleaning with fresh water on a quarterly basis is recommended in order to avoid water corrosion due to salt build-up or chlorosis. Although our products are suitable for outdoor use, during colder months the products should be stored in a closed, dry place in order to prevent moisture and seasonal frosts from affecting the finish.

I tessuti impiegati sono naturalmente resistenti agli elementi climatici, resistenti ai raggi UV ed anti-microbici. A seguito di forti precipitazioni è consigliato rimuovere i cuscini per un'asciugatura rapida e prevenire la formazione di condensa. Nel caso di collocamento degli arredi in località marittime o piscine, si consiglia una pulizia trimestrale utilizzando acqua dolce per evitare principi di corrosione dovuti ad accumuli salini o clorosi. Nonostante i nostri prodotti siano adatti all'ambiente esterno, durante il periodo invernale è consigliato il ricovero dei prodotti in un luogo chiuso ed asciutto. In modo da evitare che l'umidità unita alle gelate stagionali possa in qualche modo intaccare le finiture.

Les tissus utilisés sont naturellement résistants aux éléments climatiques, résistants aux UV et antimicrobiens. Après de fortes pluies, il est toutefois conseillé de retirer les coussins pour un séchage rapide et pour éviter la formation de condensation. Si le mobilier est placé dans des stations balnéaires ou des piscines, nous recommandons un nettoyage trimestriel à l'eau douce pour éviter la corrosion due à l'accumulation de sel ou de chlore. Bien que nos produits soient adaptés à une utilisation en extérieur, il est recommandé de les stocker dans un endroit fermé et sec pendant la période hivernale, afin d'éviter que l'humidité combinée aux gelées saisonnières n'affecte d'une manière ou d'une autre les finitions.

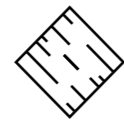

HPL
HPL/HPL

Self-supporting composite material suitable for outdoor environment. Use a soft cloth with water only for daily cleaning. If necessary, use non-aggressive detergents. Please avoid using abrasive sponges or steel wool pads. When the furniture is placed in seaside locations or swimming pools, cleaning with fresh water on a quarterly basis is recommended in order to avoid water corrosion due to salt build-up or chlorosis. Although our products are suitable for outdoor use, during colder months the products should be stored in a closed, dry place in order to prevent moisture and seasonal frosts from affecting the finish.

Materiale composito autoportante adatto all'ambiente Outdoor. Utilizzare un panno morbido con sola acqua per la pulizia quotidiana. In caso di necessità utilizzare detersivi non aggressivi. Evitare l'impiego di spugne abrasive o pagliette in acciaio. Nel caso di collocamento degli arredi in località marittime o piscine, si consiglia una pulizia trimestrale utilizzando acqua dolce per evitare principi di corrosione dovuti ad accumuli salini o clorosi. Nonostante i nostri prodotti siano adatti all'ambiente esterno, durante il periodo invernale è consigliato il ricovero dei prodotti in un luogo chiuso ed asciutto. In modo da evitare che l'umidità unita alle gelate stagionali possa in qualche modo intaccare le finiture.

Matériau composite autoportant adapté à un usage extérieur. Utilisez un chiffon doux avec de l'eau uniquement pour le nettoyage quotidien. Si nécessaire, utilisez des détergents non agressifs. Évitez d'utiliser des éponges abrasives ou des tampons de laine d'acier. Si le mobilier doit être installé dans des stations balnéaires ou des piscines, nous recommandons un nettoyage trimestriel à l'eau douce pour éviter la corrosion due au sel ou au chlore. Bien que nos produits conviennent à une utilisation en extérieur, il est recommandé, pendant la période hivernale, de stocker les produits dans un endroit fermé et sec, afin d'éviter que l'humidité combinée aux gelées saisonnières n'affecte d'une manière ou d'une autre les finitions.

STANDARD STEEL RAL COLORS

COLORI RAL STANDARD PER ACCIAIO - COULEURS RAL STANDARD POUR L'ACIER

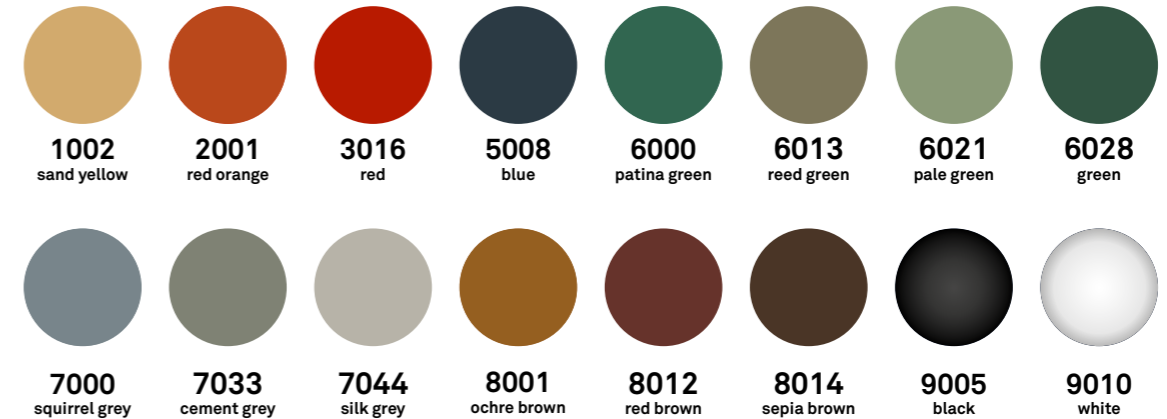

The standard finishings for the steel elements are the RAL shown. Customized RAL colors finishings are available upon request.

Le finiture standard degli elementi in acciaio sono i RAL mostrati. Su richiesta sono disponibili colorazioni customizzate su altre tinte RAL.

Les finitions standard des éléments en acier sont le RAL illustré. Des couleurs RAL personnalisées sont disponibles sur demande.



COLOR SWATCHES AND TECH INFO

CAMPIONI COLORI E INFO TECNICHE - ÉCHANTILLONS DE COULEURS ET INFOS TECHNIQUES

DOWNLOAD

Click on the image above to download the color swatches and technical informations

Clicca sull'immagine per scaricare il pdf dei campioni colori e specifiche tecniche

Cliquez sur l'image ci-dessus pour télécharger les échantillons de couleurs et les informations techniques

